

# "LCA"- long cased axial fan

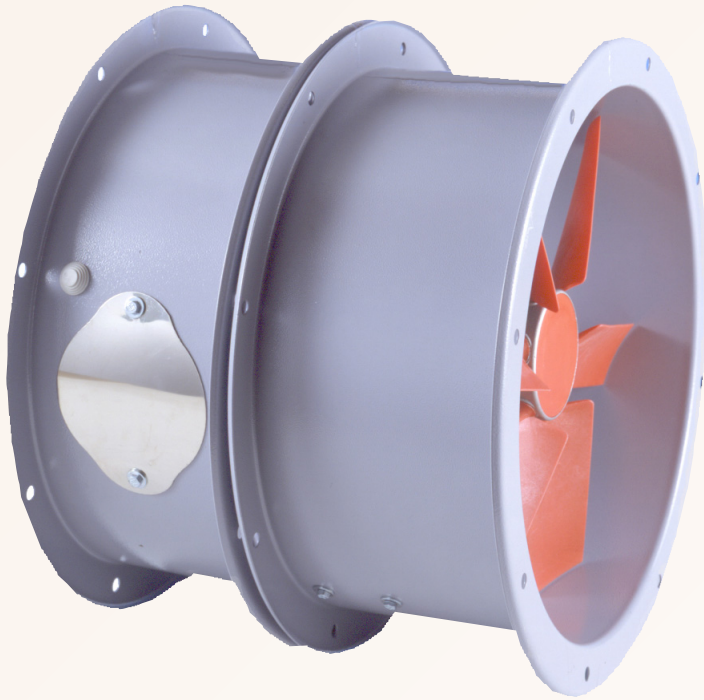

- Long cased axial fans for industrial/commercial use
- Thirteen sizes - from 310mm to 1250mm diameter
- Airflow from 2,200 to 80,000m<sup>3</sup>/hr
- Single or Three Phase
- 2, 4 or 6 pole motors
- Speed controllable
- Full range of accessories

## GENERAL

- For installation into ducting.
- For industrial and commercial installations.
- High performance rates
- Suitable for high volume, low pressure ventilation systems.
- Airflow from 0.6 to 22m<sup>3</sup>/sec.
- 8 pole motors available on certain sizes.
- Fan available in short-cased version.
- Higher performance models also available
- Can be used with speed controller (not flameproof models)

## SPECIFICATION

- Cylindrical case in epoxy painted steel plate with flange at both ends
- Blade in reinforced polypropylene (optional die-cast aluminium blade available)
- Blade hub in die-cast aluminium
- Class F motor insulation
- Suitable for operation in air temperatures between -10°C and +60°C
- IP55 protection

## COMPLY WITH

- UNI EN ISO 9000-2000 certified
- UNI ISO 6580-EUROVENT
- EC Low Voltage Directive 73/23-93/68
- EC Directive EMC89/336
- CE marked

## RANGE

- **LCA312M - LCA402M**  
3 x 2 pole, single phase models
- **LCA314M - LCA634M**  
7 x 4 pole, single phase models
- **LCA506M - LCA716M**  
4 x 6 pole, single phase models
- **LCA312T - LCA452T**  
4 x 2 pole, three phase models
- **LCA314T - LCA1004CT**  
17 x 4 pole, three phase models
- **LCA506T - LCA1256T**  
9 x 6 pole, three phase models
- **LCAFL**  
models with explosion-proof motor for installation in Zone I areas
- **LCAB**  
models with belt driven impeller and externally mounted motor
- **LCAHT**  
high temperature version for Emergency Smoke Extraction ("**Somkex**"®)
- **LCAP**  
portable cooling fans



"LCAP" model

"LCAB" model



"LCAHT" model

## TYPICAL SPECIFICATION

Supply and install a LCA404M 400mm, 4 pole, single phase long cased axial fan as supplied by Vectaire Ltd, Lincoln Road, Cressex Business Park, High Wycombe, Bucks, HP12 3RH.

This fan is to be suitable for installation in commercial premises in a high volume, low pressure ventilation system.

It is to be capable of being operated with a remote speed controller

The fan casing should be in epoxy painted steel plate with a flange at both ends. The blade should

Fan to comply with all current IEE, EC and Building Regulations requirements and be keymark approved.



Tel: +44(0)1494 522333  
Fax: +44(0)1494 522337

Vectaire Ltd  
Lincoln Road, Cressex Business Park  
High Wycombe, Buckinghamshire, HP12 3RH

Email: sales@vectaire.co.uk  
Web: www.vectaire.co.uk

# TECHNICAL CHARACTERISTICS

## INSTALLATION

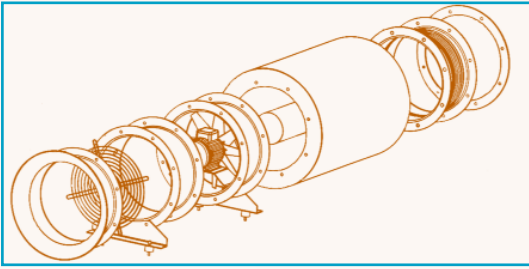

## DIMENSIONS

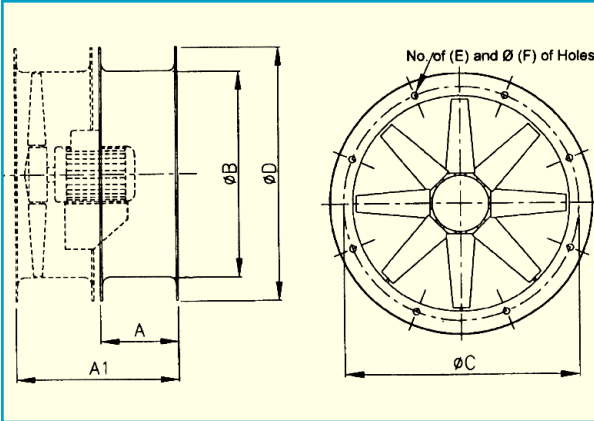

Model	A	A1	B	C	D	E	F	Kg
LCA310s	180	380	315	355	395	8	10	26
LCA350s	180	380	350	305	446	8	10	30
LCA400s	200	430	400	450	496	8	12	36
LCA450s	200	430	450	500	546	8	12	45
LCA500s	200	450	500	560	598	12	12	47
LCA560s	200	450	560	620	658	12	12	51
LCA630s	240	490	630	690	730	12	12	63
LCA710s	280	530	710	770	810	16	12	76
LCA800s	340	590	800	860	910	16	12	145
LCA900s	340	690	900	970	1030	16	16	211
LCA1000s	410	760	1000	1070	1130	16	16	254
LCA1120s	410	760	1120	1190	1250	20	16	249
LCA1250s	410	760	1250	1320	1380	20	16	285

## PRESSURE CURVES

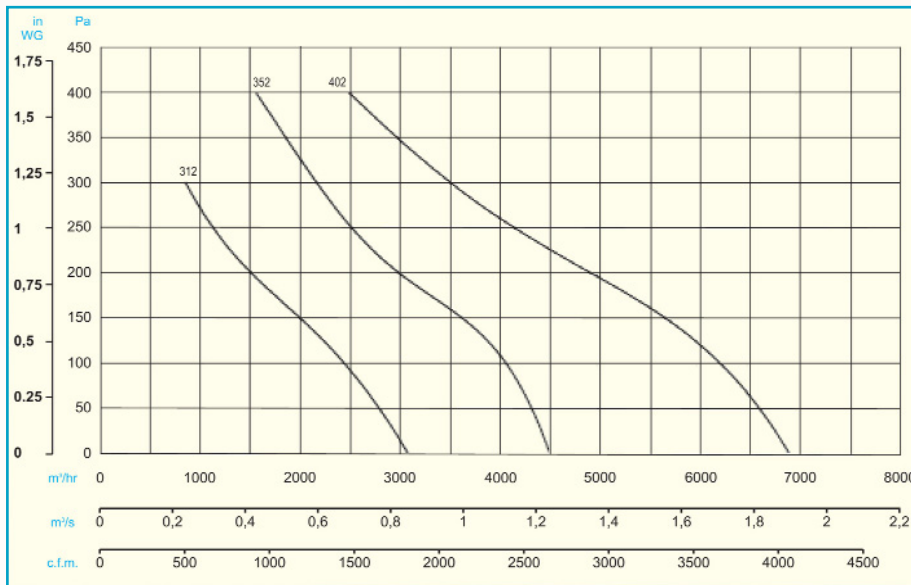

2 pole  
310-400mm diameter

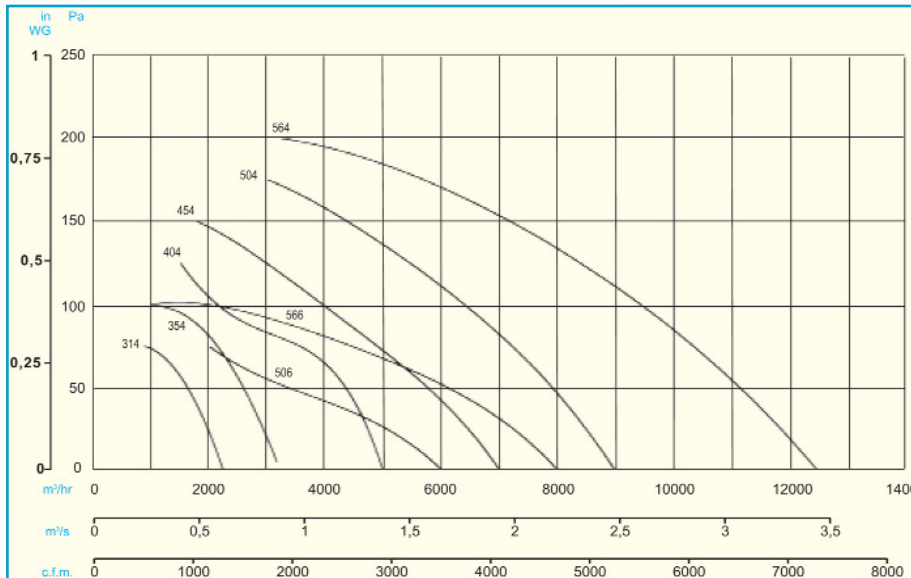

4 and 6 pole  
310-560mm diameter



4 and 6 pole  
630-800mm diameter

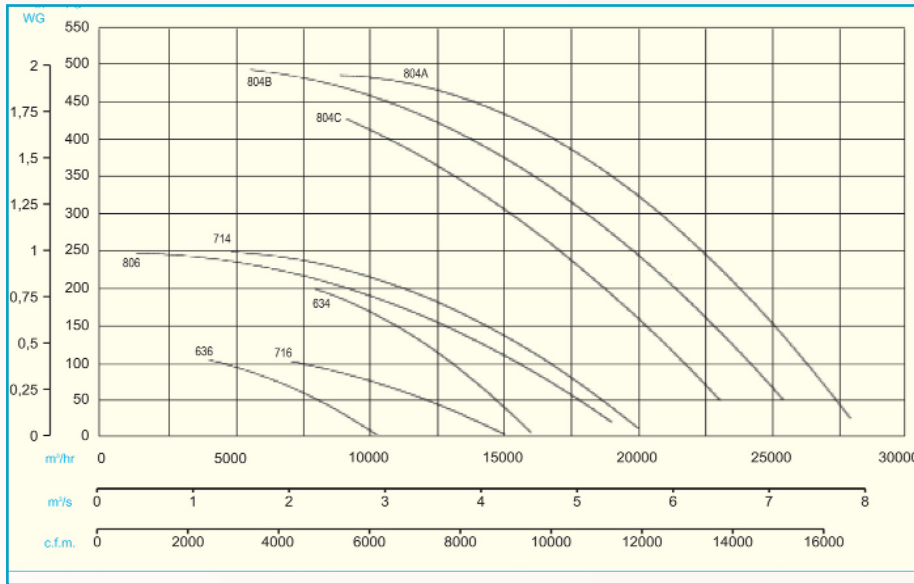

4 pole  
900-1000mm diameter

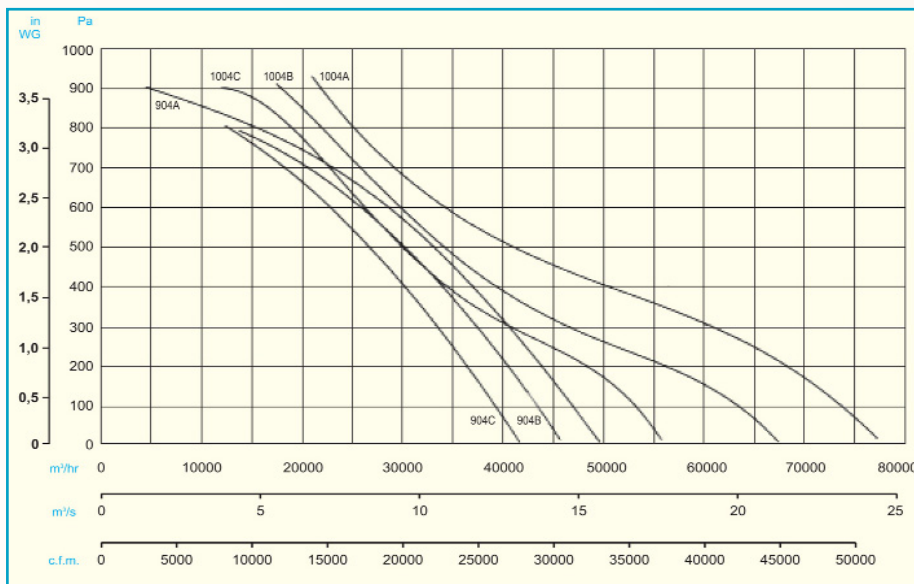

6 pole  
900-1250mm diameter

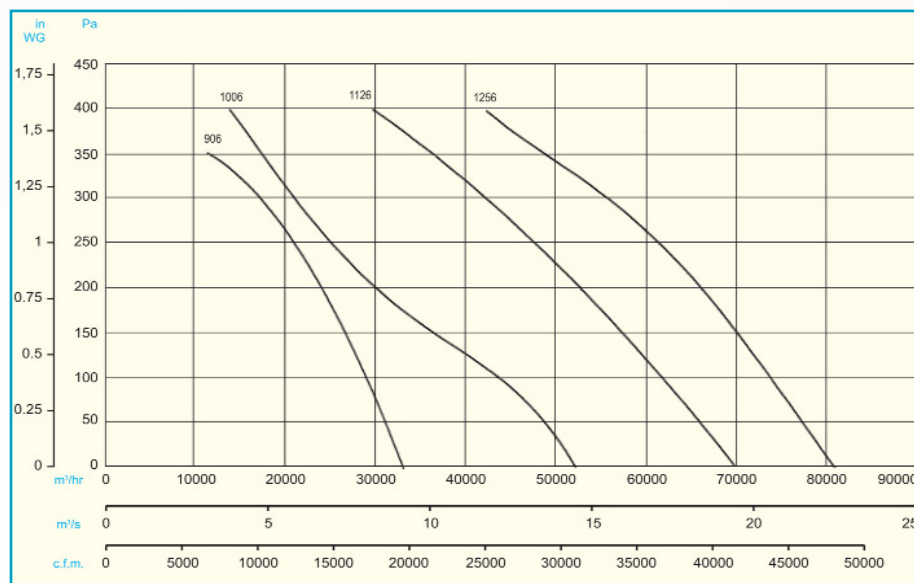

## TECHNICAL DATA



Model	Size		Pole	Power kw		Current		Max Airflow		Duty												
	ins	cm		1 ph	3 ph	1 ph	3 ph	m <sup>3</sup> /hr	cfm	0	25	50	75	100	125	150	175	200	250	300	350	400
LCA 312	12	31	2	0.25	0.25	1.70	0.78	3100	1827	0.86	0.82	0.77	0.74	0.68	0.62	0.56	0.48	0.42	0.31	0.23	-	-
LCA 314	12	31	4	0.12	0.12	1.10	0.52	2270	1338	0.63	0.55	0.46	0.25	-	-	-	-	-	-	-	-	-
LCA 352	14	35	2	0.55	0.55	4.20	1.40	4500	2655	1.25	1.23	1.21	1.18	1.13	1.07	1.01	0.93	0.84	0.70	0.60	0.51	0.43
LCA 354	14	35	4	0.12	0.12	1.10	0.52	3170	1869	0.88	0.84	0.74	0.57	0.32	-	-	-	-	-	-	-	-
LCA 402	16	40	2	1.10	1.10	6.20	2.80	6990	4125	1.93	1.88	1.85	1.80	1.73	1.66	1.58	1.50	1.38	1.15	0.98	0.83	0.69
LCA 404	16	40	4	0.18	0.18	1.60	0.65	5000	2960	1.39	1.32	1.21	1.00	0.60	0.42	-	-	-	-	-	-	-
LCA 454	18	45	4	0.37	0.37	2.90	1.20	7000	4130	1.95	1.80	1.62	1.32	1.15	0.82	0.50	-	-	-	-	-	-
LCA 504	20	50	4	-	0.55	4.3	1.60	9000	5310	2.50	2.36	2.20	2.01	1.78	1.52	1.22	0.84	-	-	-	-	-
LCA 506	20	50	6	-	0.18	1.9	0.82	6050	3568	1.68	1.42	0.95	0.56	-	-	-	-	-	-	-	-	-
LCA 564	22	56	4	-	0.75	5.4	2.00	12500	7375	3.46	3.30	3.10	2.85	2.63	2.34	2.00	1.58	0.90	-	-	-	-
LCA 566	22	56	6	-	0.26	2.3	1.10	8030	4736	2.23	2.02	1.71	1.25	0.28	-	-	-	-	-	-	-	-
LCA 634	25	63	4	-	1.10	6.7	2.80	16000	9440	4.44	4.30	4.10	3.90	3.60	3.30	3.00	2.60	2.20	-	-	-	-
LCA 636	25	63	6	-	0.37	3.2	1.20	10450	6160	2.90	2.50	2.20	1.86	1.11	-	-	-	-	-	-	-	-
LCA 714	28	71	4	-	2.20	-	5.30	20000	11800	5.55	5.40	5.20	5.00	4.70	4.40	3.90	3.50	2.90	1.33	-	-	-
LCA 716	28	71	6	-	0.75	5.3	2.50	15000	8857	4.17	3.90	3.30	2.75	1.96	-	-	-	-	-	-	-	-
LCA 806	32	80	6	-	1.50	-	4.20	19000	11210	5.28	5.20	5.00	4.70	4.40	4.15	3.55	2.90	2.10	0.35	-	-	-
LCA 906	36	90	6	-	3.00	-	7.20	33500	19753	9.30	9.00	8.70	8.25	8.00	7.70	7.50	7.20	6.70	6.10	5.00	3.20	-
LCA 1006	40	100	6	-	5.50	-	13.50	52200	30800	14.50	14.20	13.60	12.80	12.20	11.50	10.40	9.40	8.30	7.00	6.00	5.00	3.90
LCA 1126	44	112	6	-	7.50	-	17.00	69850	41200	19.40	18.90	18.40	17.90	17.30	16.70	16.10	15.20	14.40	13.50	12.00	10.30	8.30
LCA 1256	49	125	6	-	11.00	-	22.50	81000	47790	22.50	22.00	21.50	21.00	20.50	20.20	19.50	19.00	18.40	17.20	15.60	13.70	11.80

Model	Size		Pole	Power kw		Current		Max Airflow		Duty													
	ins	cm		1ph	3 ph	1ph	3 ph	m <sup>3</sup> /hr	cfm	0	50	100	150	200	250	300	350	400	500	600	700	800	900
LCA 804A	32	80	4	-	4.00	-	9.40	27900	16460	7.75	7.50	7.30	7.10	6.85	6.25	5.80	5.00	4.20	2.46	-	-	-	-
LCA 804B	32	80	4	-	4.00	-	9.40	25700	15127	7.06	6.98	6.89	6.54	6.00	5.47	4.98	4.33	3.50	1.53	-	-	-	-
LCA 804C	32	80	4	-	3.00	-	6.70	23400	13773	6.40	6.32	6.14	5.88	5.24	4.89	4.18	3.44	2.53	-	-	-	-	
LCA 904A	36	90	4	-	9.20	-	17.30	50050	29524	13.90	13.30	13.00	12.50	12.10	11.70	11.30	10.80	10.40	9.11	7.86	6.25	4.44	1.25
LCA 904B	36	90	4	-	7.50	-	15.40	45600	26839	12.67	12.42	12.07	11.65	11.24	10.79	10.42	9.93	9.44	8.33	7.03	5.56	3.81	-
LCA 904C	36	90	4	-	5.50	-	12.00	41750	24573	11.56	11.28	10.81	10.50	10.06	9.69	9.29	8.78	8.36	7.39	6.31	5.14	3.44	-
LCA1004A	40	100	4	-	15.00	-	29.00	77050	45454	21.40	20.90	20.40	19.80	19.00	18.10	16.80	15.10	13.20	11.22	9.50	8.33	7.28	5.83
LCA1004B	40	100	4	-	9.20	-	17.30	67500	39729	18.75	18.18	17.44	16.63	15.47	14.11	12.89	11.92	11.14	8.86	8.29	7.36	6.25	4.86
LCA1004C	40	100	4	-	7.50	-	15.40	55400	32607	15.44	15.22	14.76	14.36	13.19	12.06	11.14	10.38	9.67	8.35	7.28	6.28	5.22	3.33

## Please Note:

Flameproof (LCAFL) and Belt Driven (LCAB) models have the same technical characteristics as the same sized fans in the main LCA Range.



## TECHNICAL DATA

Motor Speed	Size		Single Phase (M)			Three Phase (T)		
	ins	cm	Fan	Speed Controller	DOL Starter	Fan	Speed Controller	DOL Starter
2 pole 2800 rpm	12	31	LCA312M	-	DOLS3M	LCA312T	-	DOLS1T
	14	35	LCA352M	-	DOLS6M	LCA352T	-	DOLS2T
	16	40	LCA402M	-	DOLS8M	LCA402T	-	DOLS4T
	18	45	-	-	-	LCA452T	-	DOLS6T
4 pole 1400 rpm	12	30	LCA314M	VC1	DOLS1M	LCA314T	VC2AT	DOLS1T
	14	35	LCA354M	VC1	DOLS2M	LCA354T	VC2AT	DOLS1T
	16	40	LCA404M	VC4M	DOLS3M	LCA404T	VC3AT	DOLS1T
	18	45	LCA454M	VC4M	DOLS4M	LCA454T	VC3AT	DOLS2T
	20	50	LCA504M	VC6M	DOLS6M	LCA504T	VC3AT	DOLS3T
	22	56	LCA564M	VC6AM	DOLS8M	LCA564T	VC3AT	DOLS3T
	25	63	LCA634M	VC8AM	DOLS8M	LCA634T	VC5AT	DOLS4T
	28	71	-	-	-	LCA714T	VC8AT	DOLS6T
	32	80	-	-	-	LCA804AT	-	DOLS12T
	32	80	-	-	-	LCA804BT	-	DOLS12T
	32	80	-	-	-	LCA804CT	-	DOLS8T
	35	90	-	-	-	LCA904AT	-	DOLS23T
	35	90	-	-	-	LCA904BT	-	DOLS23T
	35	90	-	-	-	LCA904CT	-	DOLS16T
	39	100	-	-	-	LCA1004AT	-	DOLS33T
39	100	-	-	-	LCA1004BT	-	DOLS23T	
39	100	-	-	-	LCA1004CT	-	DOLS23T	
6 pole 900 rpm	20	50	LCA506M	VC4M	DOLS3M	LCA506T	VC3AT	DOLS1T
	22	56	LCA566M	VC4M	DOLS3M	LCA566T	VC3AT	DOLS2T
	25	63	LCA636M	VC4M	DOLS4M	LCA636T	VC3AT	DOLS2T
	28	71	LCA716M	VC6AM	DOLS8M	LCA716T	VC3AT	DOLS2T
	32	80	-	-	-	LCA806T	VC6AT	DOLS6T
	36	90	-	-	-	LCA906T	VC8AT	DOLS8T
	39	100	-	-	-	LCA1006T	-	DOLS16T
	44	112	-	-	-	LCA1126T	-	DOLS23T
	49	125	-	-	-	LCA1256T	-	DOLS33T

### Please Note:

Flameproof fans CANNOT be used with a speed controller

## ACCESSORIES

Fan	LCA Protection Guard	Connecting Flange	Mounting Feet (Pair)	Flexible Connector	Inlet Cone	Silencer no pod	Silencer with pod	Worm Drive Clips	Anti-Vibration Mounts
LCA310s	PG310	SPIG300	MF300	FLC310	IC310	LCS310	LCSP310	WDC12/16	AVM1
LCA350s	PG350	SPIG350	MF350	FLC350	IC350	LCS350	LCSP350	WDC12/16	AVM1
LCA400s	PG400	SPIG400	MF400	FLC400	IC400	LCS400	LCSP400	WDC12/16	AVM1
LCA450s	PG450	SPIG450	MF450	FLC450	IC450	LCS450	LCSP450	WDC18/22	AVM1
LCA500s	PG500	SPIG500	MF500	FLC500	IC500	LCS500	LCSP500	WDC18/22	AVM1
LCA560s	PG560	SPIG560	MF560	FLC560	IC560	LCS560	LCSP560	WDC18/22	AVM1
LCA630s	PG630	SPIG630	MF630	FLC630	IC630	LCS630	LCSP630	WDC25	AVM1
LCA710s	PG710	SPIG710	MF710	FLC710	IC710	LCS710	LCSP710	WDC28	AVM1
LCA800s	PG800	SPIG800	MF800	FLC800	IC800	LCS800	LCSP800	WDC32	AVM2
LCA900s	PG900	SPIG900	MF900	FLC900	IC900	LCS900	LCSP900	WDC36	AVM2
LCA1000s	PG1000	SPIG1000	MF1000	FLC1000	IC1000	LCS1000	LCSP1000	WDC40	AVM2
LCA1120s	PG1120	SPIG1120	MF1120	FLC1120	IC1120	LCS1120	LCSP1120	WDC44	AVM2
LCA1250s	PG1250	SPIG1250	MF1250	FLC1250	IC1250	LCS1250	LCSP1250	WDC49	AVM2



Protection Guard



Flexible Connector



Silencer



Worm Drive Clip



Connecting Flange



Anti Vibration Mounts

FULL RANGE OF ACCESSORIES AVAILABLE INCLUDING FLEXIBLE AND FLAT DUCTING